

PV-23 Reel 550/150 19mm/25m PVC - Fire hydrant reel

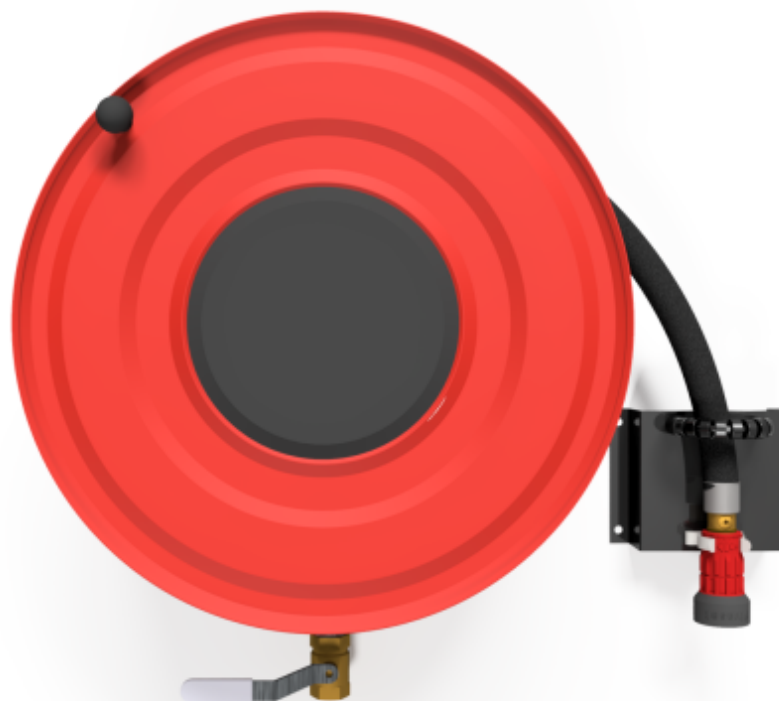

PV-23 Reel 550/150 19mm/25m PVC - Fire hydrant reel



Hose reel designed for fire hydrants. For other usage, we recommend the industrial model. Includes fire hydrant hose and direct/ fog nozzle. Equipped with a wall mounting bracket, hose guide, 1 shut-off valve, connecting hose, and rewinding knob. The CE-marked (EN 671-1:2012) fire hydrant reel is always red, and the maximum length of the hose is 30 metres.

Features

EN 671-1 / 2012 approved	YES
Hose type	PVC
Length of the hose	25
Hose inner diameter	19mm (3/4")
Width (mm)	550
Depth (mm)	230



1" female thread

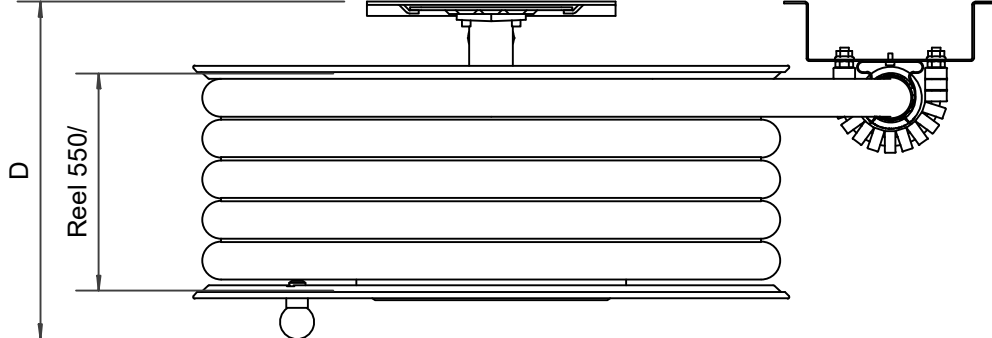

Dimension	
Reel	D
Reel 550/120	(235) mm
Reel 550/150	(265) mm
Reel 550/200	(315) mm





PV-23_Dimensional_Drawing

Luottamuksellinen Confidential
Property of PIVASET OY, Leppävirta, Finland.
Not to be handed over to, copied or used by third party.
Two- or three dimensional reproduction of contents
to be authorized by PIVASET OY.

11.12.2024