

**PV-25 Reel 550/150 19mm/25m, PVC, hinged arm - Fire hose reel**

---

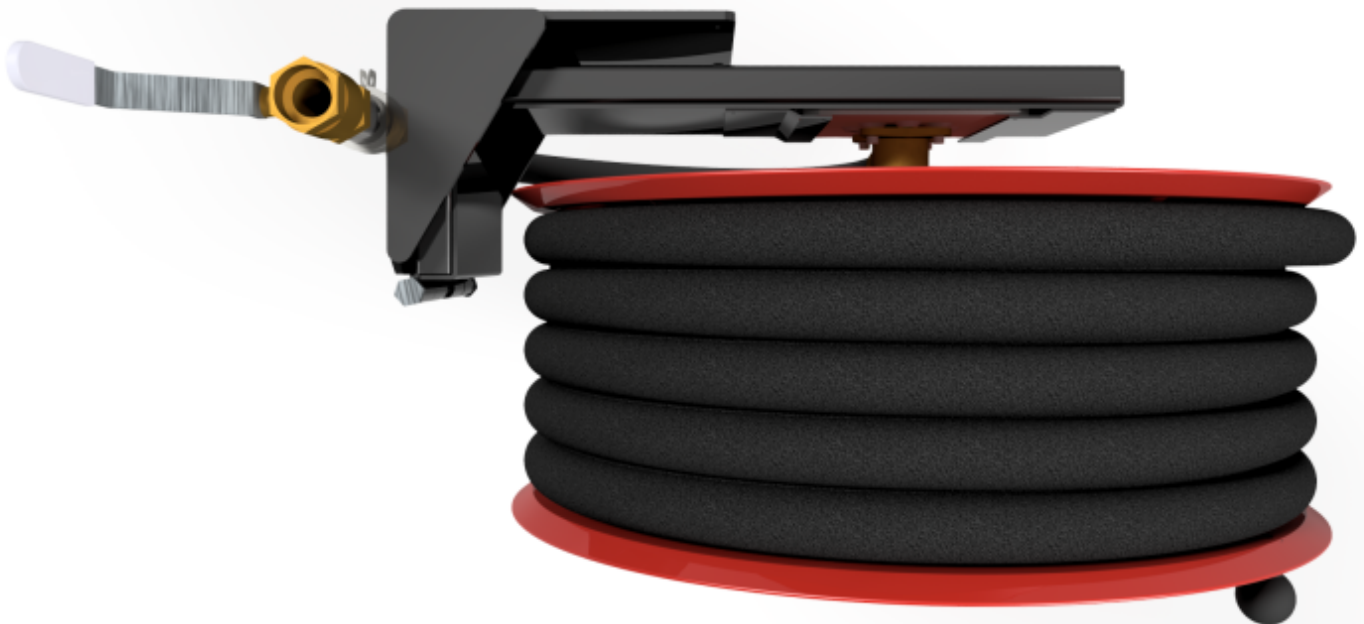

**PV-25 Reel 550/150 19mm/25m, PVC, hinged arm - Fire hose reel**

---



A hose reel designed for fire hydrants, equipped with a hinged arm for easy unravelling and rewinding of the hose (protrusion 750 mm). For other usage, we recommend the industrial model. Includes fire hydrant hose and direct/fog nozzle, 1 shut-off valve, connecting hose and rewinding knob. Hinged arm sold also separately. The CE-marked (EN 671-1:2012) fire hydrant reel is always red, and the maximum length of the hose is 30 metres.

**Features**

---

EN 671-1 / 2012 approved	YES
Hose type	PVC
Length of the hose	25
Hose inner diameter	19mm (3/4")
Height (mm)	671
Width (mm)	749
Depth (mm)	346