

PV-25 Reel 550/200 25mm/30m, PVC, hinged arm - Fire hose reel

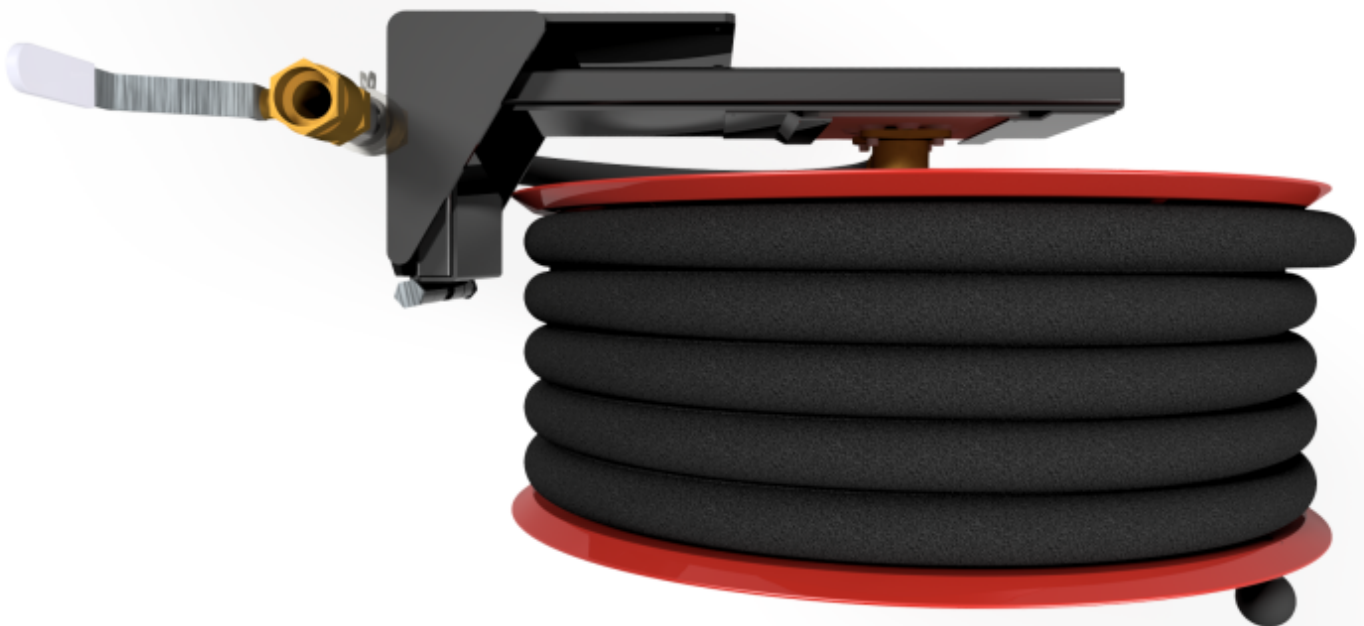

PV-25 Reel 550/200 25mm/30m, PVC, hinged arm - Fire hose reel



A hose reel designed for fire hydrants, equipped with a hinged arm for easy unravelling and rewinding of the hose (protrusion 750 mm). For other usage, we recommend the industrial model. Includes fire hydrant hose and direct/fog nozzle, 1 shut-off valve, connecting hose and rewinding knob. Hinged arm sold also separately. The CE-marked (EN 671-1:2012) fire hydrant reel is always red, and the maximum length of the hose is 30 metres.

Features

| | |
|--------------------------|-----------|
| EN 671-1 / 2012 approved | YES |
| Hose type | PVC |
| Length of the hose | 30 |
| Hose inner diameter | 25mm (1") |
| Height (mm) | 671 |
| Width (mm) | 749 |
| Depth (mm) | 346 |