

**PV-25 Trommel 550/150 19mm/25m, hengslet arm -  
Brannslangetrommel**

---

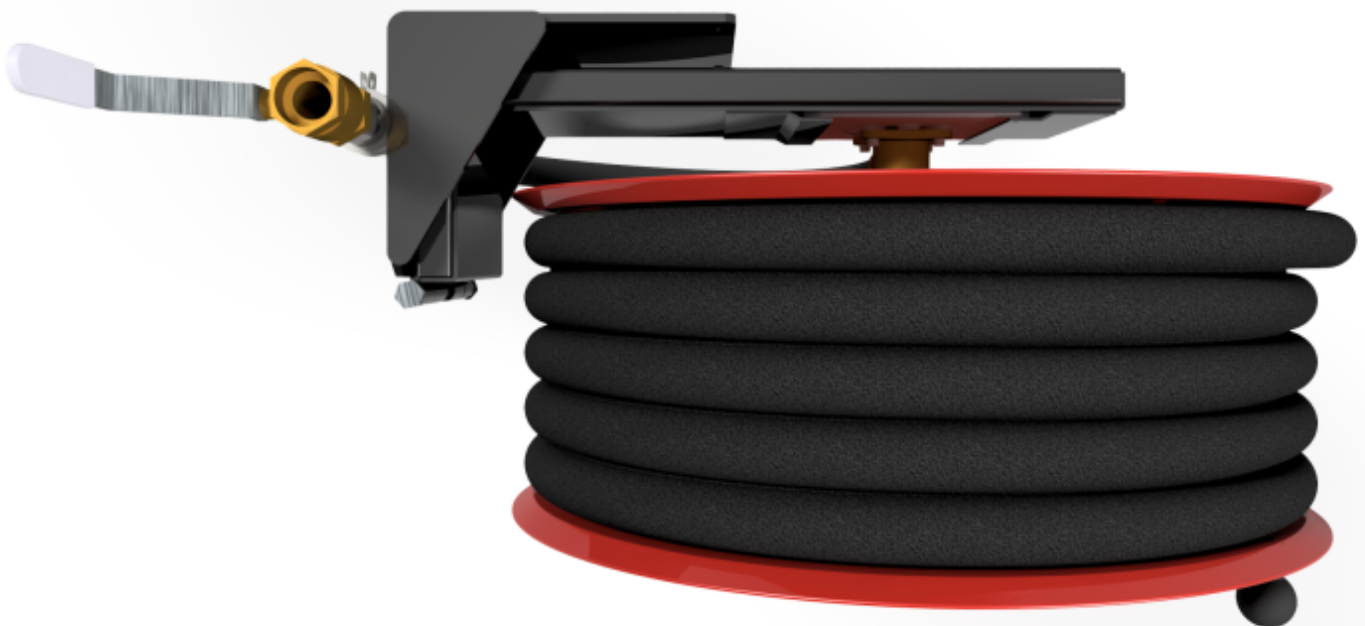

**PV-25 Trommel 550/150 19mm/25m, hengslet arm - Brannslangetrommel**

---



Slangetrommel beregnet for brannhydranter, utstyrt med en hengslet arm for enkel ut- og opprulling av slangen (utstikk på 750 mm). For annen bruk anbefaler vi industrimodellen. Inkluderer brannpostslange og direkte/tåkedyse, 1 stengeventil, tilkoblingslange og opprullingsknott. Hengslet arm selges også separat. Den CE-merkede (EN 671-1:2012) brannhydrantrullen er alltid rød, og den maksimale lengden på slangen er 30 meter.

**Features**

---

Finsk "lvi-nummer"	2956404
EN 671-1 / 2012 godkjent	JA
Slangetype	Lett slange
Lengden på slangen	25
Slangens indre diameter	19 mm (3/4")
Høyde (mm)	671
Bredde (mm)	749
Dybde (mm)	346